

SOLAR UP - UNIVERSAL PLATFORM

Fixing plate for SBS roofs

INSTALLATION



No holes



Quick installation



Lightweight



UP PARTS

UP fixing plate for SBS roof

Product No: 36300

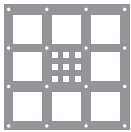

390 x 390 mm

UP SBS mat for fixing plate

Product No: 36390

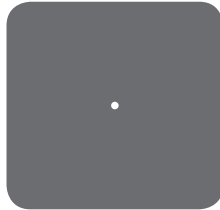

700 x 700 mm

UP Bolt set for fixing plate

Product No: 36310

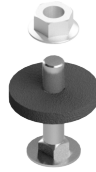

10 x Carriage-bolt M8x50 inox, Collar nut M8 inox, Gasket

SBS top sheet roll, if ready made SBS mat is not used.

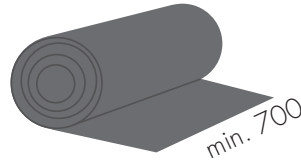

min. 700

Gas torch



Protective rubber mat

for SBS roofing Product No: 36580
for PVC-roofing Product No: 38160



140 x 300 mm

Need: 2 kpl/Smart

INSTALLATION

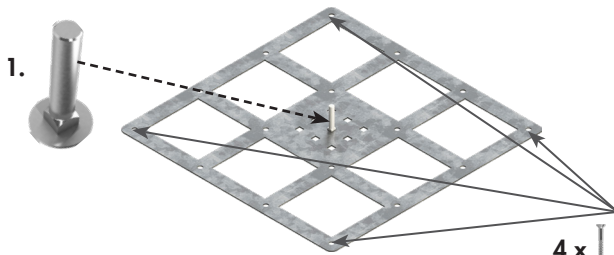

With roof pitches higher than 10° fastening into the wooden structures of the roof with low-socket inox screws is recommended.

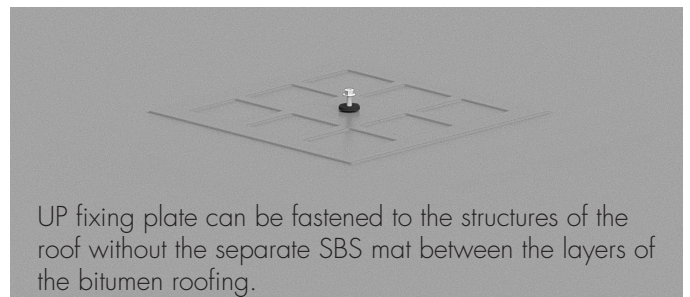
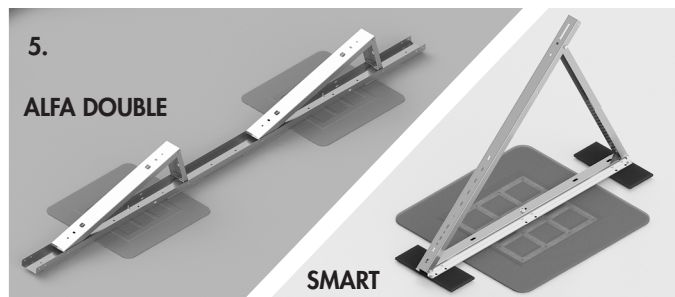
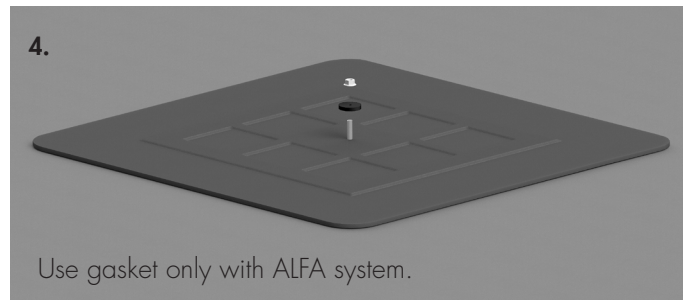
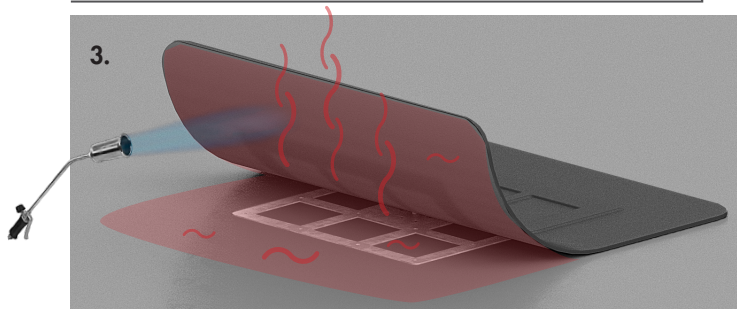
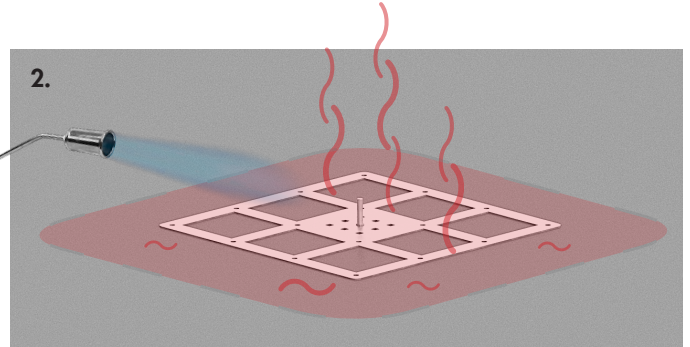

This product is developed and tested in collaboration with Katepal Oy.





Nordic solar partner

Easy Rail MOUNTING PROFILE FASTENING WITH UP PLATE

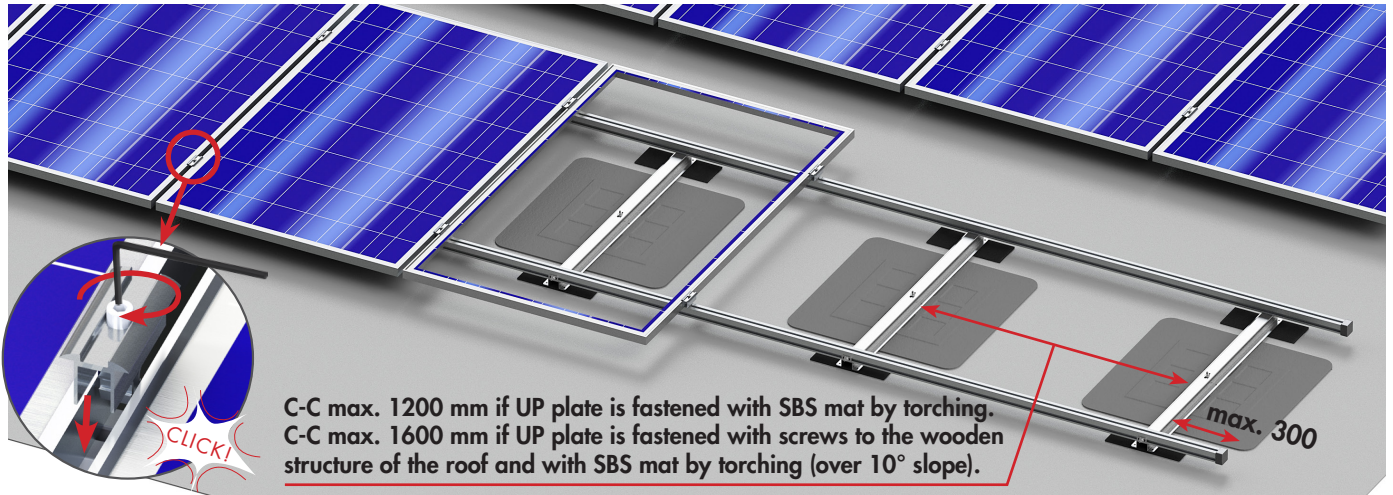

ACCESSORIES

Easy Rail Mounting Profile Fastener Set for UP Plate 38230

Inc. Easy Rail mounting profile fastener, 2 x Easy Rail T-bolt + flange nut and 2 x protective rubber mat.

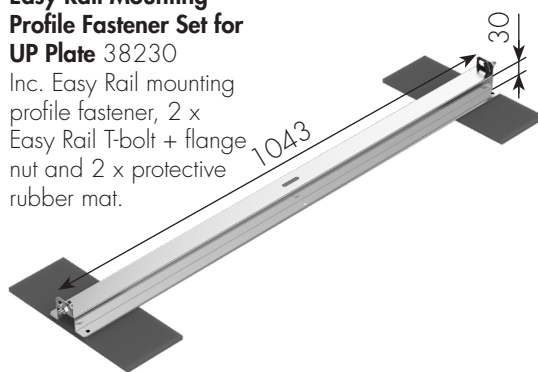

Easy Rail Mounting Profile 3,1 m 36600
6,2 m 36480
Joint Set 2 pc. 36750
End Caps 4 pc. 36720

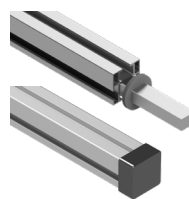

Easy Rail Middle Clamp 35 mm 10 pc. 36540
black 3654033
40 mm 10 pc. 36780
black 3678033

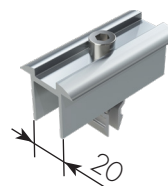

Easy Rail End Clamp 35 mm 8 pc. 36530
black 3653033
40 mm 8 pc. 36770
black 3677033

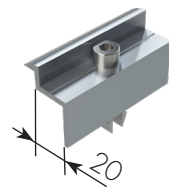

1. FASTENING TO THE UP PLATE

Use the UP bolt set to fasten the mounting profile fastener to the UP plate. Place the protective rubber mats under the both ends of the fastener.

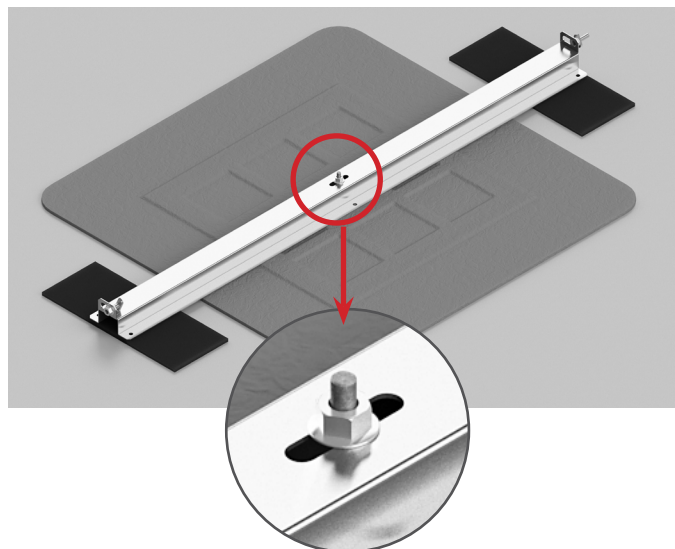

2. FASTENING OF THE EASY RAIL MOUNTING PROFILES

Every mounting profile must be fastened with at least two roof fasteners. Notice the thermal expansion: The length of the one profile line is max. 15 meters.

